



# OWNER'S INSTRUCTIONS

## Indoor unit

AQ07S8GE  
AQ07SBGE  
SH07ZS8  
AQ09S8GE  
AQ09SBGE  
SH09ZS8  
AQ12SBGE  
AQ12SGGB  
AQ12SGGE  
SH12ZSG  
AQ18S0GB  
AQ18S0GE  
SH18ZS0  
AQ24S6GB  
AQT24S6GE  
SH24TS6

## Outdoor unit

UQ07S8GE  
UQ07SBGE  
SH07ZS8X  
UQ09S8GE  
UQ09SBGE  
SH09ZS8X  
UQ12SBGE  
UQ12SGGB  
UQ12SGGE  
SH12ZSGX  
UQ18S0GB  
UQ18S0GE  
SH18ZS0X  
UQ24S6GB  
UQT24S6GE  
SH24TS6X

## SPLIT TYPE ROOM AIR CONDITIONER ( Cool and Heat )

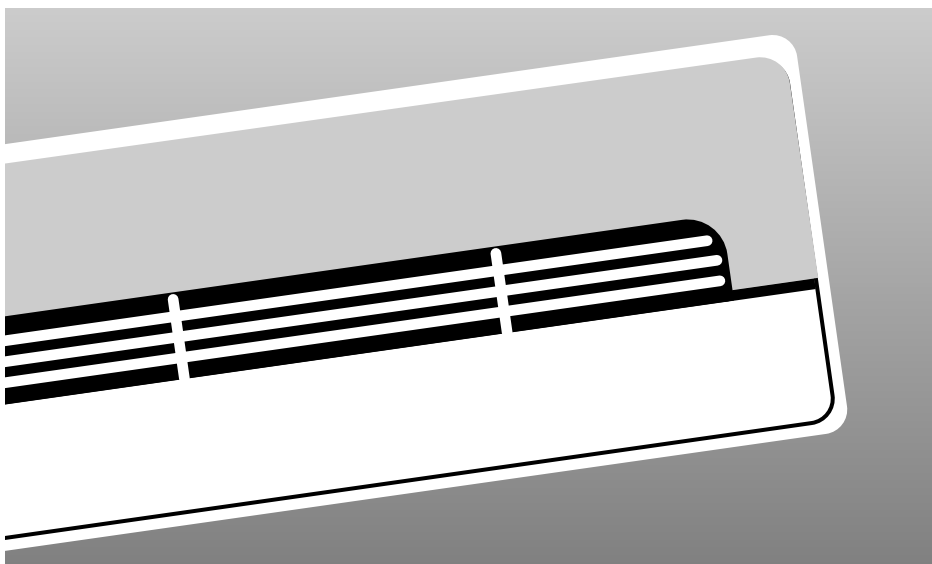

## Safety Precautions

---



### **WARNING**

- ◆ If the power supply cord of this air conditioner is damaged, it must be replaced by the manufacturer or its authorized service personnel only in order to avoid a safety hazard.



### **DANGER**

- ◆ Do not attempt to install the air conditioner by yourself.
- ◆ This unit contains no user-serviceable parts. Always consult authorized service personnel for repairs.
- ◆ When moving, consult authorized service personnel for disconnection and installation of the unit.
- ◆ Do not become over-exposed to cold air by staying in the direct path of the air flow of the air conditioner for extended periods of time.
- ◆ Do not insert fingers or objects into the outlet port or intake grilles.
- ◆ Do not start and stop air conditioner operation by disconnecting the power supply cord and so on.
- ◆ Take care not damage the power supply cord.
- ◆ In the event of a malfunction(burning smell, etc.), immediately stop operation, turn off the electrical breaker, and consult authorized service personnel.



### **CAUTION**

- ◆ Provide occasional ventilation during use.
- ◆ Do not direct air flow at fireplaces or heating apparatus.
- ◆ Do not climb on, or place objects on, the air conditioner.
- ◆ Do not hang objects from the indoor unit.
- ◆ Do not set flower vases or water containers on top of air conditioner.
- ◆ Do not expose the air conditioner directly to water.
- ◆ Do not touch the power supply plug with wet hands.
- ◆ Do not turn off the air conditioner with pulling power cord.
- ◆ Turn off power source when not using the unit for extended periods.
- ◆ Do not place animals or plants in the direct path of the air flow.
- ◆ Do not drink the water drained from the air conditioner.
- ◆ Do not use in applications involving the storage of foods, plants or animals, precision equipment, of art works.
- ◆ Do not block or cover the intake grille and outlet port in use.
- ◆ Do not use inflammable gases near the air conditioner.
- ◆ If the supply cord is damaged, it must be replaced by a special cord or assembly available from the manufacturer or its service agent. (For Europe)
- ◆ Before throwing out the device, it is necessary to pull back the battery cells and get rid of them safely.

# Contents

---

◆ <b>PREPARING YOUR AIR CONDITIONER</b>	
■ Safety Precautions .....	2
■ View of the Unit .....	4
■ Remote Control-Buttons and Display .....	6
■ Getting Started .....	7
■ Inserting the Remote Control Batteries .....	8
◆ <b>OPERATING YOUR AIR CONDITIONER</b>	
■ Selecting the Automatic Operating Mode .....	9
■ Cooling Your Room .....	10
■ Heating Your Room .....	11
■ Changing the Room Temperature Quickly .....	12
■ Removing Excess Humidity .....	13
■ Airing Your Room .....	14
■ Selecting Energy Saving Mode .....	15
■ Adjusting the Air Flow Direction Vertically .....	16
■ Adjusting the Air Flow Direction Horizontally .....	17
◆ <b>PROGRAMMING YOUR AIR CONDITIONER</b>	
■ Setting the On Timer .....	18
■ Setting the Off Timer .....	19
■ Setting the Sleep Timer .....	20
◆ <b>RECOMMENDATIONS FOR USE</b>	
■ Operating Recommendations .....	21
■ Temperature and Humidity Ranges .....	22
■ Operating Your Air Conditioner Without the Remote Control .....	22
■ Solving Common Problems .....	23
■ Cleaning Your Air Conditioner .....	24
■ Cleaning Deodorizing and Bio-Green filters (option) .....	24
◆ <b>TECHNICAL SPECIFICATIONS</b>	

## View of the Unit

The design and shape are subject to change according to the model.

### Indoor Unit

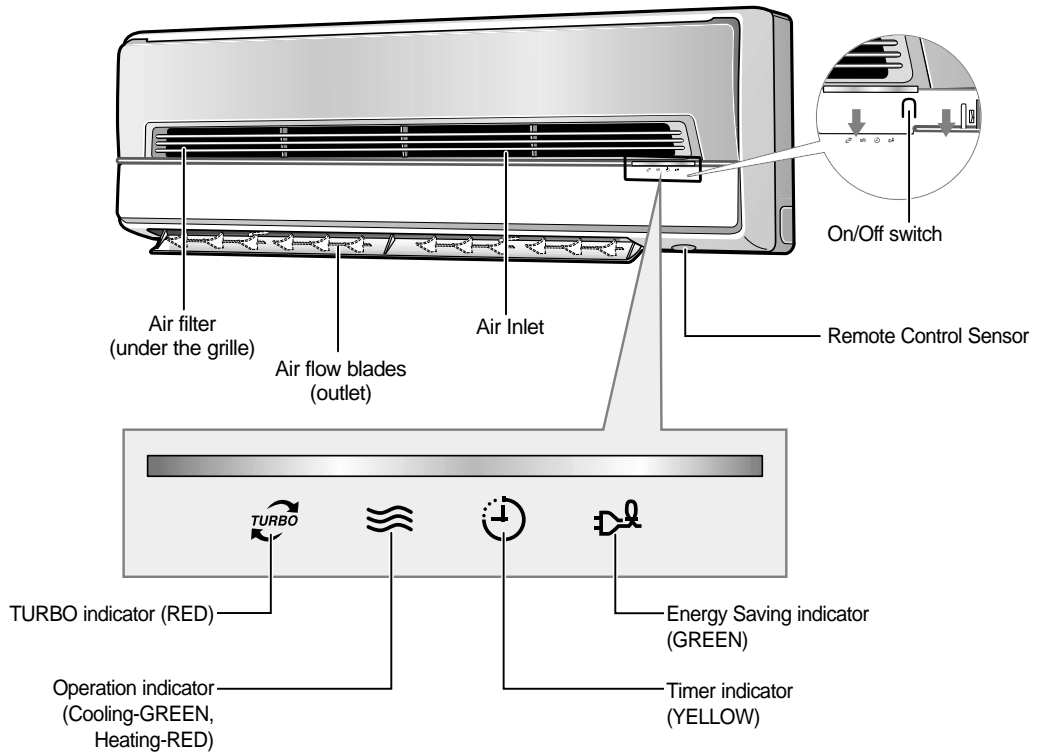

**Outdoor Unit**

UQ07S8GE SH07ZS8X UQ09S8GE SH09ZS8X

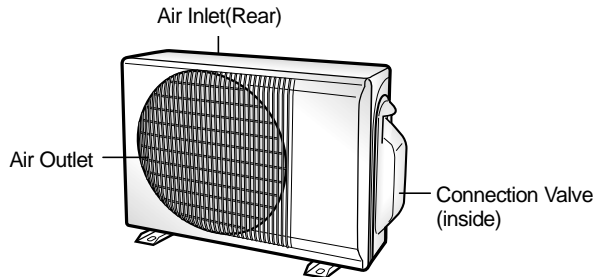

**Outdoor Unit**

UQ07SBGE UQ09SBGE UQ12SBGE

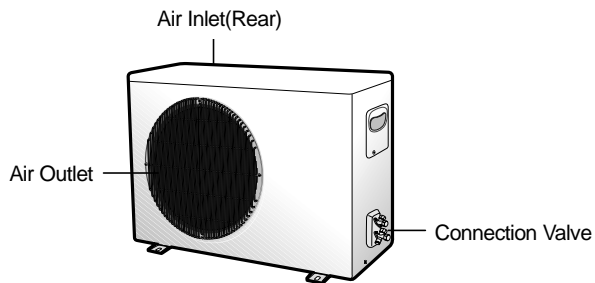

**Outdoor Unit**

UQ12SGGB UQ12SGGE SH12ZSGX

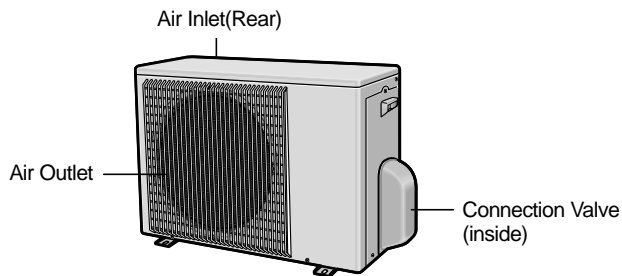

**Outdoor Unit**

UQ18S0GB UQ18S0GE SH18ZS0X  
UQ24S6GB UQT24S6GE SH24TS6X

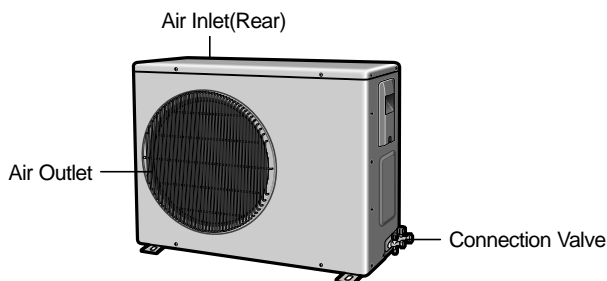

# Remote Control - Buttons and Display

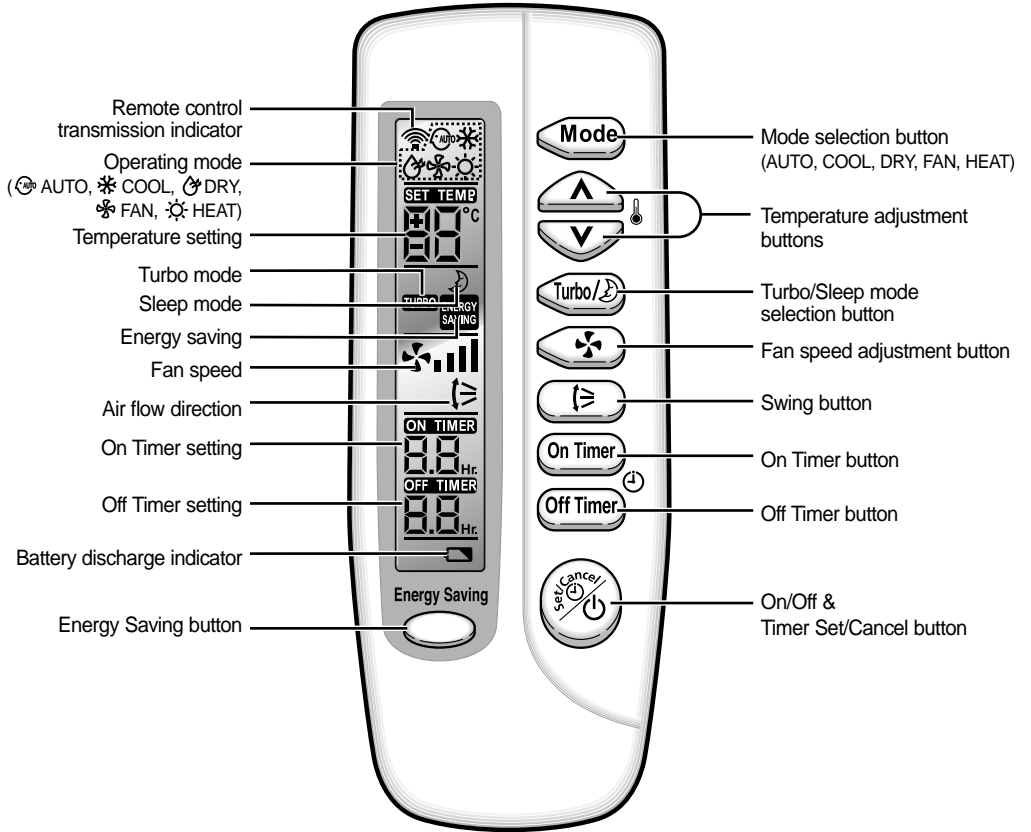

# Getting Started

*You have just purchased a split type air conditioner and it has been installed by your installation specialist.*

*Your Owner's Instructions contains valuable information on using your air conditioner. Please take the time to read it as it will help you take full advantage of the unit's features.*

*The booklet is organized as follows.*

- ◆ *The following figures are shown on pages from 4 to 6 :*
  - *Indoor and outdoor units*
  - *Remote control(buttons and display)**They will help you find the buttons and understand the symbols displayed.*
  
- ◆ *In the main part of the installation book, you will find a series of step-by-step procedures for each function available.*

*The illustrations in the step-by-step procedures use three different symbols:*

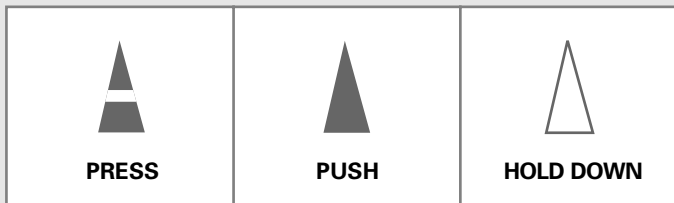

## Inserting the Remote Control Batteries

**You must insert or replace the remote control batteries when :**

- ◆ **You purchase the air conditioner**
- ◆ **The remote control does not work correctly**

**Note**

- ◆ Use two AAA, LR03 1.5V batteries.
- ◆ Do not use old batteries or different kinds of batteries together.
- ◆ Batteries may be completely discharged after 12 months, even if they have not actually been used.

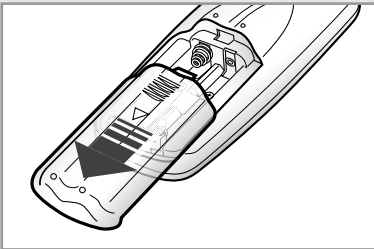

- 1 Push the battery cover on the rear of the remote control with your thumb in the direction of the arrow and remove it.

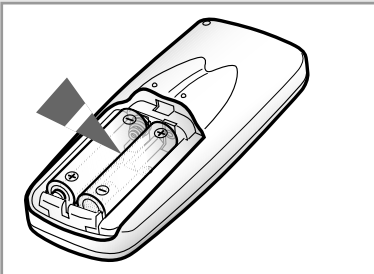

- 2 Insert the two batteries, taking care to respect the polarities :
  - ◆ + on the battery with + on the remote control.
  - ◆ - on the battery with - on the remote control.

- 3 Close the cover by sliding it back until it clicks into place.



# Selecting the Automatic Operating Mode

**You can start the air conditioner in Automatic mode from your remote control. In the Automatic mode, the standard temperature and the optimum fan speed is selected automatically. You can adjust the standard temperature but not the fan speed.**



1 If necessary, press the  (On/Off) button.

- Result:**
- ◆ The operation indicator on the indoor unit lights up.
  - ◆ The air conditioner starts up in the mode selected when the unit was last used.
  - ◆ The indoor unit beeps.

**IMPORTANT** The air conditioner is fitted with a protection mechanism to prevent the unit from being damaged when it is started immediately after being:

- ◆ Plugged in
- ◆ Stopped

It will start up normally after three minutes.

2 If the  is not displayed at the top of the remote control, press the  button on the remote control one or more times until it appears.

- Result:**
- ◆ The indoor unit beeps each time you press the  button.
  - ◆ The air conditioner runs in AUTO mode.

**Note** You can change modes at any time.

3 To adjust the standard temperature (The air conditioner automatically set the standard temperature by the current room temperature.), press the  button one or more times.

SET TEMP.	SET TEMP.	-	SET TEMP.	SET TEMP.
-2°C	-1°C	Standard temperature	+1°C	+2°C

< When you feel hot >

< When you feel chilly >

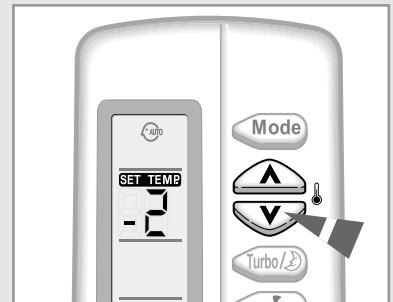
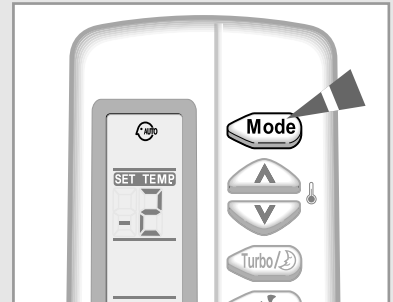
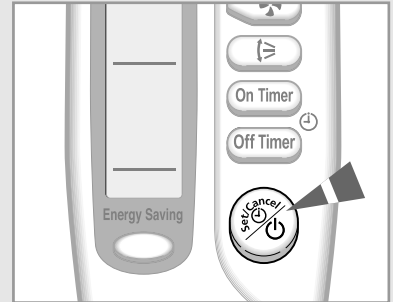

# Cooling Your Room

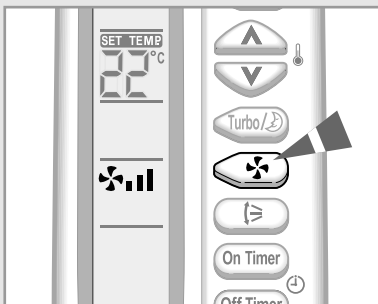
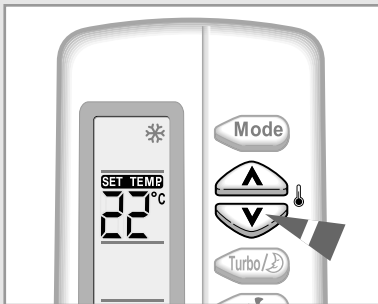
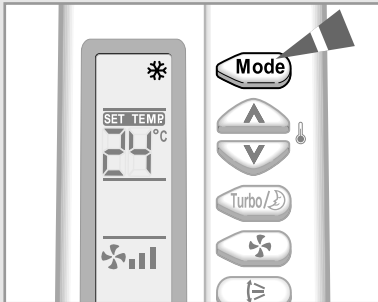
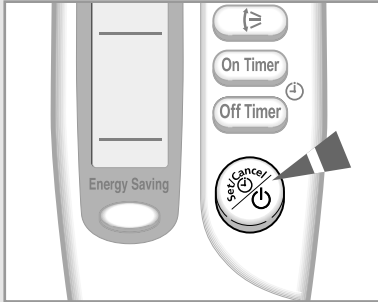

**You must select the Cool mode if you wish to adjust the:**

- ◆ **Cooling temperature**
- ◆ **Fan speed when cooling**

1 If necessary, press the (On/Off) button.

- Result:**
- ◆ The operation indicator on the indoor unit lights up.
  - ◆ The air conditioner starts up in the mode selected when the unit was last used.
  - ◆ The indoor unit beeps.

**IMPORTANT** The air conditioner is fitted with a protection mechanism to prevent the unit from being damaged when it is started immediately after being:

- ◆ Plugged in
- ◆ Stopped

It will start up normally after three minutes.

2 If the is not displayed at the top of the remote control, press the button on the remote control one or more times until it appears.

- Result:**
- ◆ The indoor unit beeps each time you press the button.
  - ◆ The air conditioner runs in COOL mode.

**Note** You can change modes at any time.

3 To adjust the temperature, press the button one or more times until the required temperature is displayed.

Possible temperatures are between 18°C and 30°C inclusive.

- Result:**
- ◆ Each time you press the button:
    - The temperature is adjusted by 1°C
    - The indoor unit beeps
  - ◆ The air conditioner starts cooling, provided that the room temperature is higher than the selected temperature.
  - ◆ If the room temperature reaches the set temperature, the air conditioner stops cooling, but the fan is still operating.

4 Select the fan speed by pressing the button one or more times until the required setting is displayed:

- Automatic (rotated : → → )
- Low
- Medium
- High

- Result:** Each time you press the button, the indoor unit beeps.

5 To control the direction of the air flow, refer to pages 16 and 17.

# Heating Your Room

You must select the Heat mode if you wish to adjust the:

- ◆ Heating temperature
- ◆ Fan speed when heating



1 If necessary, press the  (On/Off) button.

- Result:**
- ◆ The operation indicator on the indoor unit lights up.
  - ◆ The air conditioner starts up in the mode selected when the unit was last used.
  - ◆ The indoor unit beeps.

**IMPORTANT** The air conditioner is fitted with a protection mechanism to prevent the unit from being damaged when it is started immediately after being:

- ◆ Plugged in
- ◆ Stopped

It will start up normally after three minutes.

2 If the  is not displayed at the top of the remote control, press the  button on the remote control one or more times until it appears.

- Result:**
- ◆ The indoor unit beeps each time you press the  button.
  - ◆ The air conditioner runs in HEAT mode.





**Note** You can change modes at any time.

3 To adjust the temperature, press the  button one or more times until the required temperature is displayed.

Possible temperatures are between 16°C and 30°C inclusive.

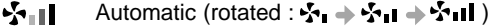
- Result:**
- ◆ Each time you press the  button:
    - The temperature is adjusted by 1°C
    - The indoor unit beeps
  - ◆ The air conditioner starts heating, provided that the room temperature is lower than the desired temperature (selected temperature+3°C).
  - ◆ If the room temperature reaches the set temperature, the air conditioner stops heating, but the fan is still operating.

4 Select the fan speed by pressing the  button one or more times until the required setting is displayed:

-  Automatic (rotated : )
-  Low
-  Medium
-  High

- Result:**
- ◆ Each time you press the  button, the indoor unit beeps.
  - ◆ For the first three to five minutes, the fan operates very slowly until the air has been sufficiently warmed. Once the correct temperature has been reached, the fan is automatically set to the required speed.

5 To control the direction of the air flow, refer to pages 16 and 17.

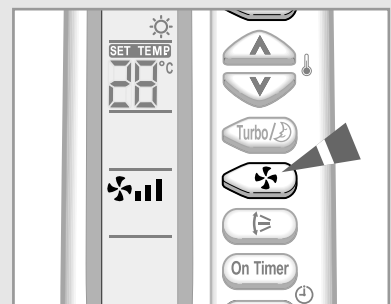
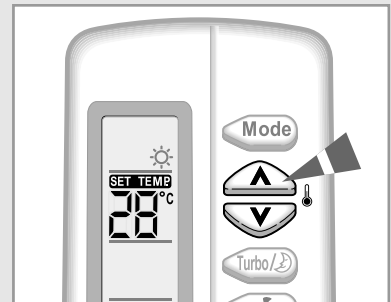
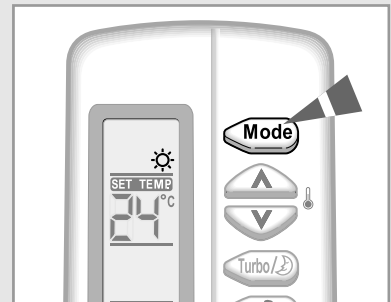
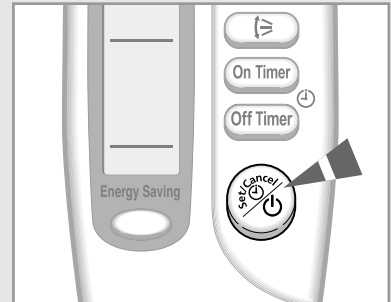



## Changing the Room Temperature Quickly

*The Turbo cooling/heating function is used to cool or heat your room as quickly as possible.*

**Example :** *You have just come home and find that the room is very hot. You wish to cool it down as quickly as possible.*

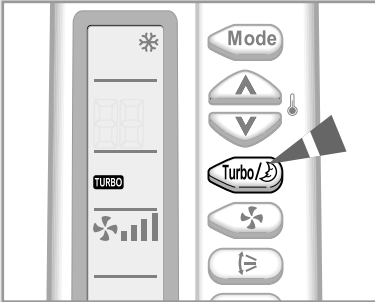
*The Turbo function operates for 30 minutes with the maximum settings before returning automatically to the mode and temperature previously selected.*



1 If necessary, press the  (On/Off) button.



Result:

- ◆ The operation indicator on the indoor unit lights up.
- ◆ The air conditioner starts up in the mode selected when the unit was last used.
- ◆ The indoor unit beeps.

2 Press the  button.

Result:

- ◆ The temperature and fan settings are adjusted automatically.
- ◆ The air conditioner cools or heats the room as quickly as possible.
- ◆ After 30 minutes, the air conditioner is reset automatically to the previous mode, temperature and fan settings.  
But, if you press the  button in DRY or FAN mode, it will change to AUTO mode automatically.

3 If you wish to stop the Turbo function before the end of the 30-minute period, press the  button one or more times until **TURBO** or  disappears.

Result:

- ◆ The air conditioner is reset automatically to the previous mode, temperature and fan settings.

4 To control the direction of the air flow, refer to pages 16 and 17.

## Removing Excess Humidity

**If the atmosphere in your room is very humid or damp, you can remove excess humidity without lowering the room temperature too much.**

- 1 If necessary, press the  (On/Off) button.



**Result:**

- ◆ The operation indicator on the indoor unit lights up.
- ◆ The air conditioner starts up in the mode selected when the unit was last used.
- ◆ The indoor unit beeps.

**IMPORTANT** The air conditioner is fitted with a protection mechanism to prevent the unit from being damaged when it is started immediately after being:

- ◆ Plugged in
- ◆ Stopped

It will start up normally after three minutes.

- 2 If the  is not displayed at the top of the remote control, press the  button on the remote control one or more times until it appears.

**Result:**

- ◆ The indoor unit beeps each time you press the  button.
- ◆ The air conditioner runs in DRY mode.

**Note** You can change modes at any time.

- 3 To adjust the temperature, press the  button one or more times until the required temperature is displayed.

Possible temperatures are between 18°C and 30°C inclusive.

**Result:**

- ◆ Each time you press the  button:
  - The temperature is adjusted by 1°C
  - The indoor unit beeps
- ◆ The air conditioner starts removing the excess humidity; the quantity of air is adjusted automatically.

- 4 To control the direction of the air flow, refer to pages 16 and 17.

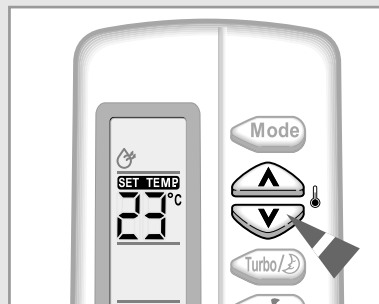
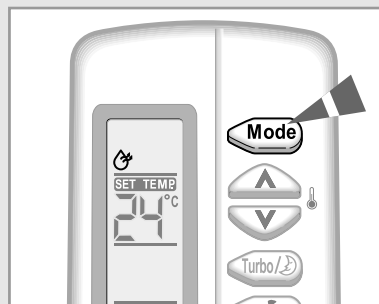
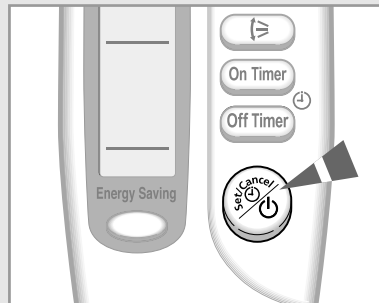

## Airing Your Room

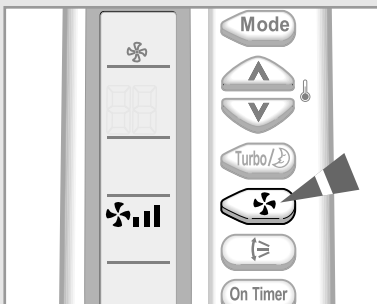
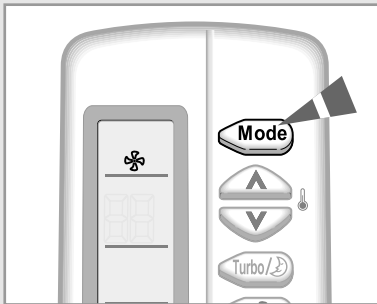
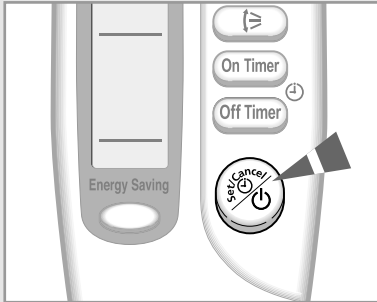

**If the atmosphere in your room is stale, you can air the room using the Fan feature.**



- 1 If necessary, press the  (On/Off) button.

**Result:**

- ◆ The operation indicator on the indoor unit lights up.
- ◆ The air conditioner starts up in the mode selected when the unit was last used.
- ◆ The indoor unit beeps.



- 2 If the  is not displayed at the top of the remote control, press the  button on the remote control one or more times until it appears.

**Result:**

- ◆ The indoor unit beeps each time you press the  button.
- ◆ The air conditioner runs in FAN mode.
- ◆ The temperature is set automatically.

**Note** You can change modes at any time.

- 3 Select the fan speed by pressing the  button one or more times until the required setting is displayed:

 Low  
 Medium  
 High

**Result:** Each time you press the  button, the indoor unit beeps.

- 4 To control the direction of the air flow, refer to pages 16 and 17.

## Selecting Energy Saving Mode

**If you wish to save energy when using your air conditioner, select the Energy saving mode with the Energy saving button.**

- 1 If necessary, press the  (On/Off) button.

**Result:**

- ◆ The operation indicator on the indoor unit lights up.
- ◆ The air conditioner starts up in the mode selected when the unit was last used.
- ◆ The indoor unit beeps.

**IMPORTANT** The air conditioner is fitted with a protection mechanism to prevent the unit from being damaged when it is started immediately after being:

- ◆ Plugged in
- ◆ Stopped

It will start up normally after three minutes.

- 2 Select COOL mode by pressing the  button.

**Note** You can select the Energy saving mode only in COOL mode.

- 3 Press the  button.

**Result:**

- ◆ The indoor unit beeps.
- ◆ The air conditioner runs in the Energy saving mode.
- ◆ The outer air flow blade moves up and down.
- ◆ To stop the Energy saving mode, press the  again.

- 4 To adjust the temperature, press the  button one or more times until the required temperature is displayed. Possible temperatures are between 26°C and 30°C inclusive.

**Note** If you want to adjust temperature under 26°C, cancel the Energy saving mode before adjusting the temperature.

- 5 To select the fan speed, press the  button one or more times until the required setting is displayed.

- 6 To control the direction of the air flow, refer to pages 16 and 17.

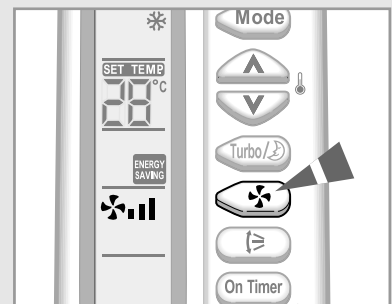
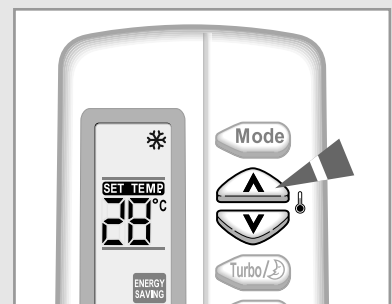
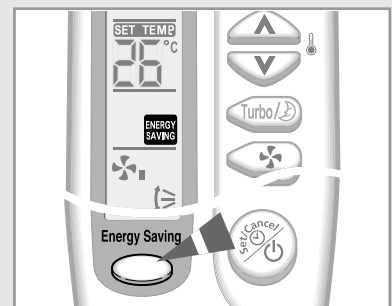
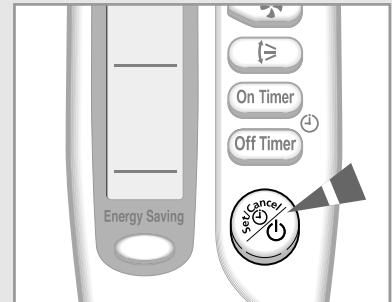

## Adjusting the Air Flow Direction Vertically

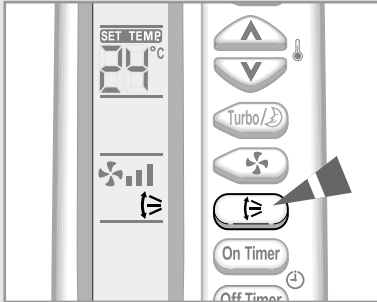

**Depending on the position of the indoor unit on the wall of your room, you can adjust the position of the outer air flow blade on the bottom of the unit, thus increasing the efficiency of the air conditioner.**

- 1 Press the  button one or more times as required.

**Result:** The outer blade is adjusted vertically.

### **RECOMMENDATION**

When...	Adjust the blade to face...
Cooling	Upwards.
Heating	Downwards.

- 2 If you want the blade to move up and down automatically when the air conditioner is operating, press the  button.

**Result:** The blade move up and down, around the base position set.

- 3 To stop the blade moving up and down, press the  button again.

**Note** *If you switch the air conditioner... Then the blade is...*

Off	Closed completely.
On again	Set to the initial position powered.



## Adjusting the Air Flow Direction Horizontally

*There are two sets of inner air flow blades. Just as the outer air flow blade can be adjusted vertically, the inner blades can be adjusted horizontally.*

- 1 Adjust each set of inner blades to the required position, by pushing or pulling them sideways.

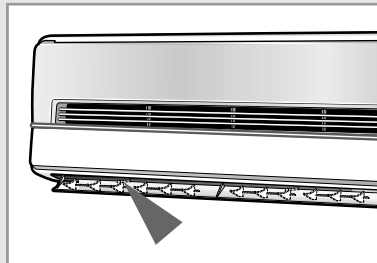

## Setting the On Timer

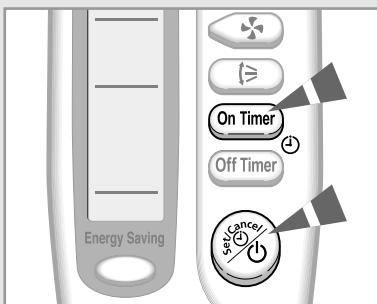
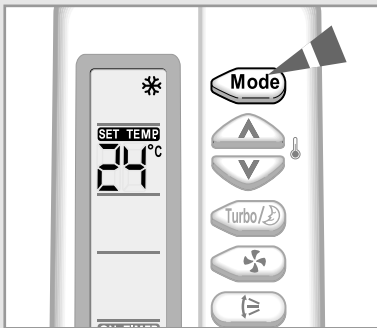
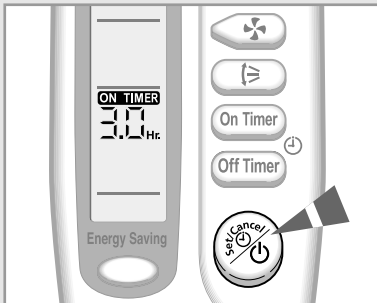
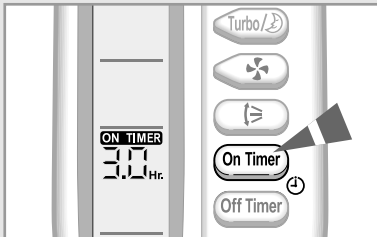

**The On Timer enables you to switch on the air conditioner automatically after a given period of time. You can set the period of time from 30 minutes to 24 hours.**

- 1 To set the operating time, press the **On Timer** button one or more times until the required time is displayed. Possible time is between 0.5 hour and 24 hour inclusive.
- 2 Press the **Set/Cancel** button to complete the setting.  
**Result:**
  - ◆ The remaining time is displayed.
  - ◆ Blinking of the timer indicator stops.
  - ◆ The selected mode and the temperature on the display disappear after 10 seconds.
  - ◆ The air conditioner will switch on automatically when the counter displayed on the remote control reaches the set time and disappears the On timer setting.
- 3 To select an operating mode in advance, press the **Mode** button until the desired mode is displayed at the top of the remote control.  
**Result:**
  - ◆ The air conditioner will run in the selected mode when it is turned on.

## To Cancel the On Timer

- 1 To cancel the On Timer, press the **On Timer** button one or more times until the timer setting disappears.
- 2 Press the **Set/Cancel** button.

**Note** If you want to turn on the air conditioner before the timer reaches the setting time, press the **ON/OFF** button.

## Setting the Off Timer

**The Off Timer enables you to switch off the air conditioner automatically after a given period of time. You can set the period of time from 30 minutes to 24 hours.**

- 1 To set the operating time, press the **Off Timer** button one or more times until the required time is displayed. Possible time is between 0.5 hour and 24 hour inclusive.

- 2 Press the **Set/Cancel** button to complete the setting.

**Result:**

- ◆ The remaining time is displayed.
- ◆ Blinking of the timer indicator stops.
- ◆ The air conditioner will switch off automatically when the counter displayed on the remote control reaches the set time and disappears the Off timer setting.

**Example** If you would like to turn the air conditioner on after 2 hours and to operate it for 2 hours:

1. Press the **On Timer** button until '2.0 Hr' is displayed.
2. Press the **Set/Cancel** button.
3. Press the **Off Timer** button until '4.0 Hr' is displayed.
4. Press the **Set/Cancel** button.

**Note** You can see or change the setting mode and/or the temperature by pressing the **Mode** button or the **Up/Down** button after setting the Off timer.

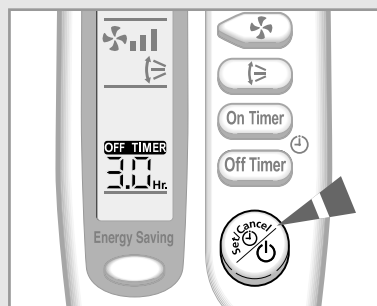

## To Cancel the Off Timer

- 1 To cancel the Off Timer, press the **Off Timer** button one or more times until the timer setting disappears.

- 2 Press the **Set/Cancel** button.

**Note** If you want to turn off the air conditioner before the timer reaches the setting time, press the **ON/OFF** button.

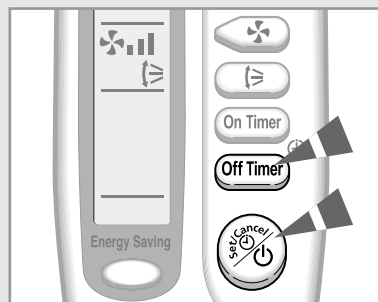



## Setting the Sleep Timer

**The Sleep Timer can be used when you are cooling or heating your room to switch the air conditioner off automatically after a period of six hours.**

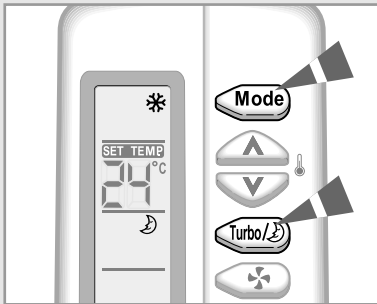
**Note** If you wish to switch the unit off at a specific time, refer to page 19.



- 1 Make sure that you have selected either COOL or HEAT mode.
- 2 Press the  button one or more times until  appears on the remote control.

**Result:**

- ◆ The indoor unit beeps.
- ◆ The air conditioner will be controlled as indicated in the illustrations below.

**Cooling** The desired temperature is increased by 1°C every hour. When it has been increased by 2°C (after two hours), the temperature is maintained for four hours.

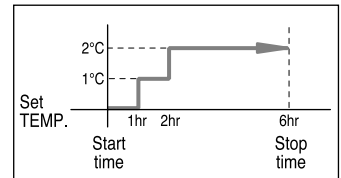

**Heating** The desired temperature is decreased by 1°C every hour. When it has been decreased by 2°C (after two hours), the temperature is maintained for four hours.

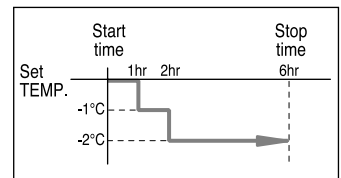

## To Cancel the Sleep Timer

**If you no longer wish to use the Sleep Timer that you have set, you can cancel it at any time.**

Press the  button.

**Result:**

- ◆ The indoor unit beeps.
- ◆ The  is no longer displayed.
- ◆ The air conditioner operates normally.

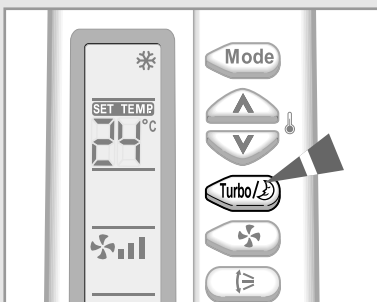

## Operating Recommendations

***Here are a few recommendations that you should follow when using your air conditioner.***

Topic	Recommendation
Heating performances	The heat pump inside the air conditioner absorbs heat from outside air and brings it indoors. If the temperature of the outside air drops, the air conditioner will heat less. If you find that the room is not warm enough, use an additional heating appliance.
Warm air circulation	The air conditioner circulates warm air to heat your room; as a result, some time will be required after starting the air conditioner to warm the entire room. If necessary, set the air conditioner on before you wish to use the room.
Frost	When outside temperatures are low and humidity is high, frost may form in the outdoor unit when heating is selected. If this happens: <ul style="list-style-type: none"><li>◆ The heating operation is stopped.</li><li>◆ The Deice mode is triggered automatically for about seven minutes.</li></ul> No intervention is required from you; after about seven minutes, the air conditioner starts operating again normally.
High indoor and outdoor temperatures	If both the indoor and outdoor temperatures are high and you select the Heat mode, the outdoor unit's fan and compressor may stop at times. This is normal; simply wait until the air conditioner switches on again.
Power failure	If a power failure occurs when the air conditioner is operating, the unit is switched off. When the power returns, the air conditioner starts up again automatically.

## Temperature and Humidity Ranges

*The following table indicates the temperature and humidity ranges within which the air conditioner can be used.*

If the air conditioner is used at...	Then...
High temperatures	The automatic protection feature may be triggered and the air conditioner stopped.
Low temperatures	A water leak or some other malfunction may occur if the heat exchanger freezes.
High humidity levels	Water may condense on and drip from the surface of the indoor unit if it is used for long periods.

Mode	Outdoor Temperature	Indoor Temperature	Indoor Humidity
Heating	0°C to 24°C approx.	27°C or less	-
Cooling	21°C to 43°C approx.	18°C to 32°C approx.	80% or less
Drying	18°C to 43°C approx.	18°C to 32°C approx.	-

\* *If the heating operation is used at below 0°C(outdoor temperature) then, it does not heat at its full capacity.  
If the cooling operation is used at over 33°C(indoor temperature) then, it does not cool at its full capacity.*

## Operating Your Air Conditioner Without the Remote Control

*Your air conditioner can be operated directly from the indoor unit if the remote control is lost or broken.*

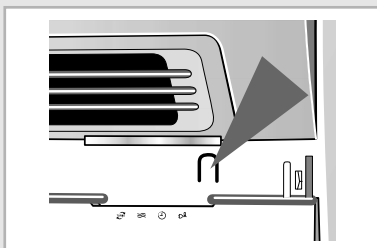
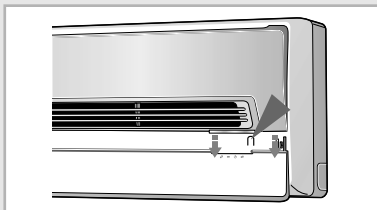

- Slide the lower front grille down.
- To switch the air conditioner on, press the ON/OFF switch on the right side of the indoor unit.

**Result:**

- ◆ The OPERATION indicator on the indoor unit comes on.
- ◆ The indoor unit beeps.
- ◆ The air conditioner starts up in the most suitable mode for the room temperature:





Room Temperature	Operating Mode	Temperature Setting
Less than 21°C	Heat	22°C approx.
21°C or above	Cool	24°C approx.

- To switch the air conditioner off, press the ON/OFF switch again.

**Note** Even if the air conditioner has been switched on via the ON/OFF switch, operations can still be controlled using the remote control as usual.

## Solving Common Problems

**Before contacting the after-sales service, perform the following simple checks. They may save you the time and expense of an unnecessary call.**

Problem	Explanation/Solution
The air conditioner does not operate at all	<ul style="list-style-type: none"> <li>◆ Check that the breaker used for the air conditioner is switched on.</li> <li>◆ Check that the operation indicator on the indoor unit is on; if necessary press the  (On/Off) button on the remote control.</li> <li>◆ Check whether the TIMER indicator on the indoor unit is switched on. If so:               <ul style="list-style-type: none"> <li>- Wait until the switch-on time is reached and the air conditioner starts up automatically</li> <li>- Cancel the timer (see pages 18 and 19 for further details)</li> </ul> </li> </ul>
The air conditioner does not operate with the remote control	<ul style="list-style-type: none"> <li>◆ Check that there are no obstacles between you and the indoor unit.</li> <li>◆ Check the remote control batteries.</li> <li>◆ Check that you are close enough to the indoor unit (seven meters/ yards or less).</li> </ul>
No beep is heard when you press the  (On/Off) on the remote control	<ul style="list-style-type: none"> <li>◆ Check that you are pointing the remote control at the remote control sensor in the right of the indoor unit.</li> <li>◆ Replace the remote control batteries if necessary.</li> </ul>
The air conditioner does not cool or heat	<ul style="list-style-type: none"> <li>◆ Check that the correct operating mode has been selected (AUTO, COOL, HEAT).</li> <li>◆ The room temperature may be too low or too high.</li> <li>◆ Dust may be blocking the air filter guard; refer to page 24 for cleaning instructions.</li> <li>◆ Check that there is no obstacle in front of the outdoor unit.</li> </ul>
When heating, the required room temperature is never reached and the air conditioner frequently stops	<ul style="list-style-type: none"> <li>◆ Check that the required temperature has been set correctly.</li> <li>◆ Increase the fan speed.</li> <li>◆ If the air flow is directed upwards, use the remote control to direct it downwards.</li> </ul>
The fan speed does not change when you press the  button	<ul style="list-style-type: none"> <li>◆ Check that the operating mode is set to COOL, HEAT or FAN ; in the AUTO mode, the fan speed changes automatically and in the DRY mode, it is set to AUTO.</li> </ul>
The air flow direction does not change when you press the  button	<ul style="list-style-type: none"> <li>◆ Check that the air conditioner has been switched on; if necessary, press the  (On/Off) button on the remote control.</li> </ul>
The timer is not correctly triggered	<ul style="list-style-type: none"> <li>◆ Check that the timer has been programmed correctly; see pages 18 and 19.</li> </ul>
Odours are permeated in the room during air conditioning	<ul style="list-style-type: none"> <li>◆ Air the room.</li> </ul>

## Cleaning Your Air Conditioner

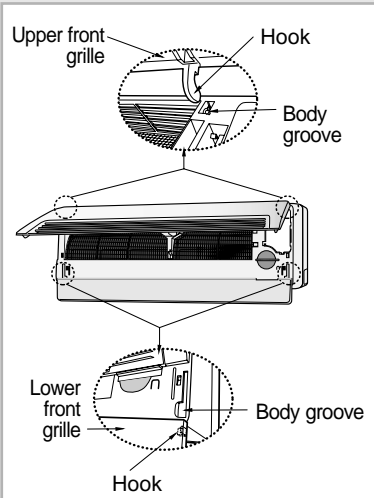
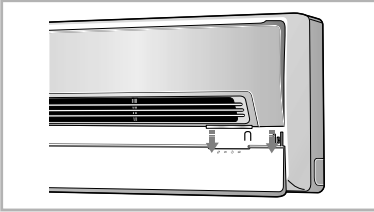

*To get the best possible use out of your air conditioner, you must clean it regularly to remove the dust that accumulates on the air filter.*

**IMPORTANT** Before cleaning your air conditioner, ensure that you have switched off the breaker used for the unit.

- 1 Slide the lower front grille down.
- 2 Open the upper front grille by pulling right and left sides of the grille.
- 3 Lift out the bottom edge of the air filters and pull down to release them.
- 4 Remove all dust on the air filters with a vacuum cleaner or brush.
- 5 When you have finished, insert the top part of the filters into their slot and push down on the bottom edge until they click into place.
- 6 Clean the front grille with a damp cloth and mild detergent (do NOT use benzene, solvents or other chemicals).

**Note** ♦ If you have not used the air conditioner for a long period of time, set the fan going for three to four hours to dry the inside of the air conditioner thoroughly.

## Cleaning Deodorizing and Bio-Green filters (Option)

\*\*07/09\*\*

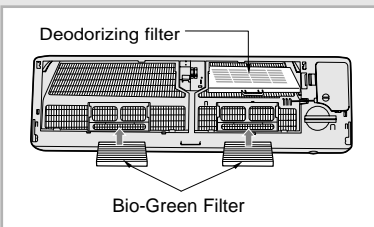

\*\*12/18/24\*\*

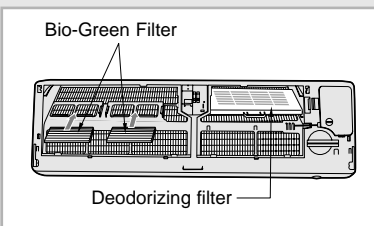

*To remove minute dust particles and odors, deodorizing and Bio-Green filters are installed in the air conditioner. You should clean the filters every 3 months.*

- 1 Open the upper front grille by pulling right and left sides of the grille.
- 2 Pull out the deodorizing and Bio-Green filters.
- 3 Wash the filters with clean water, then dry them in the shade.
- 4 Insert the filters into the original position.
 

**Note** You can change the position of filters with each other.
- 5 Close the front grille.



## Technical Specifications

Model Indoor unit	Power Supply
AQ07S8GE	
AQ07SBGE	
SH07ZS8	
AQ09S8GE	
AQ09SBGE	
SH09ZS8	
AQ12SBGE	220-240V~, 50Hz
AQ12SGGE	
SH12ZSG	
AQ18S0GE	
SH18ZS0	
AQT24S6GE	
SH24TS6	
AQ12SGGB	
AQ18S0GB	220V~, 60Hz
AQ24S6GB	

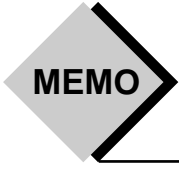

---

A series of horizontal dotted lines for writing, starting below a solid horizontal line and extending across the width of the page.

---

A series of horizontal dotted lines for writing, consisting of 20 lines.

**THIS AIR CONDITIONER IS MANUFACTURED BY:**

